

BLANCO

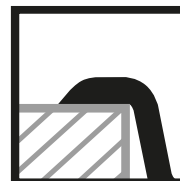

BLANCO GmbH + Co KG
Technischer Kundendienst
Tel.: +49 7045 44-81 419
info@blanco.de · www.blanco.de

BLANCO

225359 09/2011



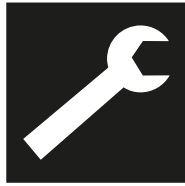
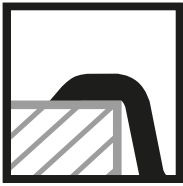

✓ OK
✗ not OK

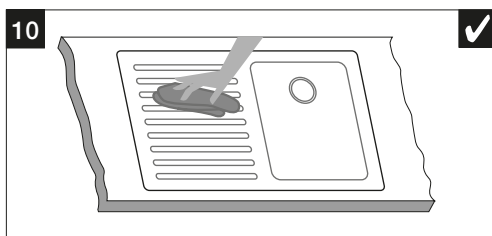
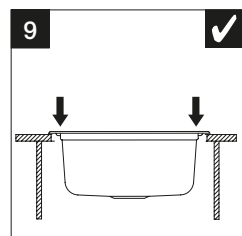
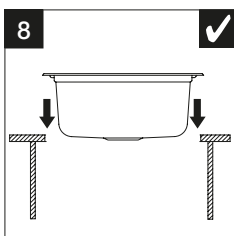
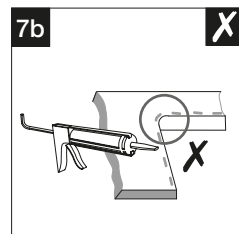
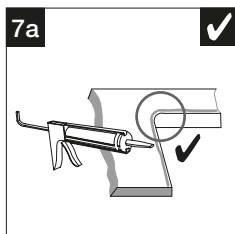
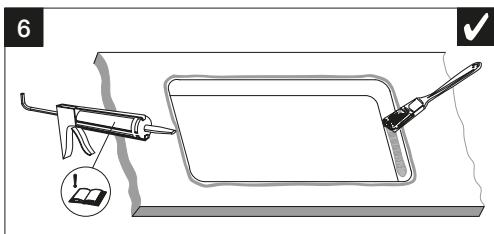
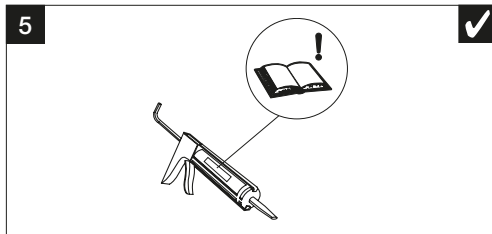
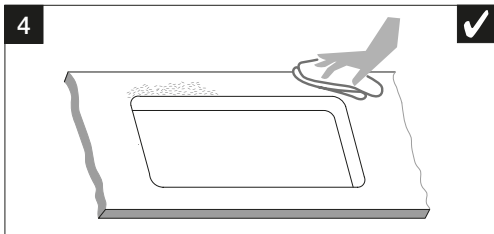
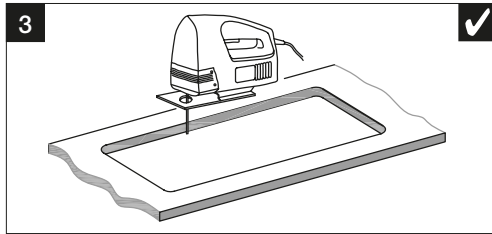
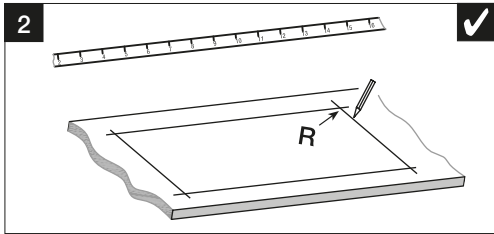
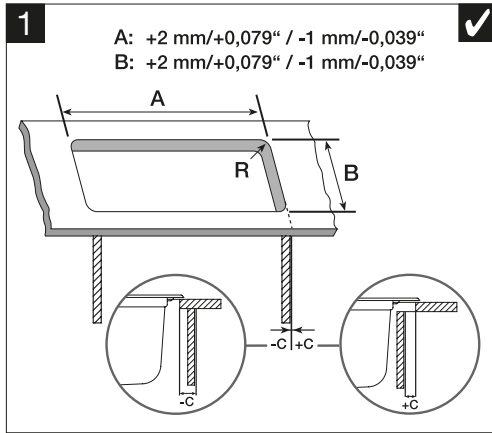
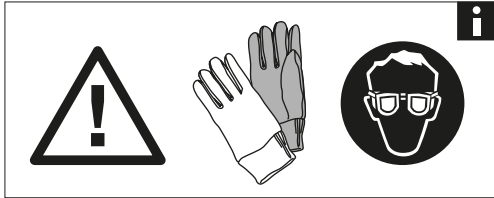

	+2 mm/+0,079" / -1 mm/-0,039"				C (mm/inch)		R (mm/inch)	
	A (mm/inch)		B (mm/inch)					
BLANCOAXON II 6 S	977 mm	38.465"	488 mm	19.213"	+6 mm	+0.236"	15 mm	0.591"
BLANCOIDESSA 45 S	758 mm	29.843"	478 mm	18.819"	-7 mm	-0.276"	15 mm	0.591"
BLANCOIDESSA 5 S	892 mm	35.118"	478 mm	18.819"	-4 mm	-0.157"	15 mm	0.591"
BLANCOIDESSA 6 S	977 mm	38.465"	478 mm	18.819"	-6 mm	-0.236"	15 mm	0.591"
BLANCOIDESSA 8 S	1140 mm	44.882"	480 mm	18.898"	-5 mm	-0.197"	15 mm	0.591"
BLANCOIDESSA 9	840 mm	33.071"	480 mm	18.898"	-30 mm	-1.181"	15 mm	0.591"
BLANCOPRION 45 S	758 mm	29.843"	488 mm	19.213"	-4 mm	-0.157"	5 mm	0,197"
BLANCOPRION 5 S	892 mm	35.118"	488 mm	19.213"	-8 mm	-0.315"	5 mm	0,197"
BLANCOPRION 6 S	977 mm	38.465"	488 mm	19.213"	-8 mm	-0.315"	5 mm	0,197"
BLANCOSETURA 5 S	810 mm	31,890"	460 mm	18,110"	-20 mm	-0,787"	15 mm	0.591"
BLANCOSETURA 6 S	950 mm	37,402"	460 mm	18,110"	-12 mm	-0,472"	15 mm	0.591"
BLANCOZENAR 45 S	837 mm	32.953"	488 mm	19.213"	-5 mm	-0.197"	15 mm	0,591"
BLANCOZENAR XL 6 S	977 mm	38.465"	488 mm	19.213"	-19 mm	-0.748"	15 mm	0,591"